

Owner's Manual

Please read before using this unit.

DVD/CD Player

DVL150F

SYLVANIA

INSTRUCCIONES EN ESPAÑOL INCLUIDAS.

Supplied Accessory

- Remote control (NB064UD) with two AA batteries
- Audio/Video cables (WPZ0102TM015/ WPZ0102LTE01/ WPZ0102CAB01)
- Owner's Manual (1VMN20433)

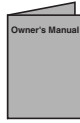
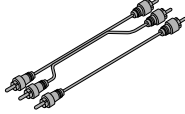

Connecting to RF Modulator

If your TV has AUDIO/VIDEO input jacks, see the section "Connections" on page 6. If not, it is still possible to connect this unit to your TV by using a STEREO AUDIO/VIDEO RF Modulator (commercially available). In this case, follow the instructions below.

- 1) Connect the AUDIO/VIDEO output jacks of this unit to the AUDIO/VIDEO input jacks of your RF Modulator by audio and video cables.
 - 2) The antenna input jack of your TV may have been already occupied. If so, disconnect the RF cable from your TV, then connect the RF cable to your RF Modulator (usually marked "ANT IN").
 - 3) Connect your RF modulator to your TV by another RF cable.
 - 4) Set your RF modulator's channel 3/4 switch to either 3 or 4, whichever the TV channel is least used in your area. If your RF modulator has a Modulator/Antenna switch, set it according to your RF modulator's manual.
 - 5) Turn on your TV and choose the same channel as you set the RF modulator's channel 3/4 switch to.
- For more details, follow the instructions supplied with the RF Modulator.

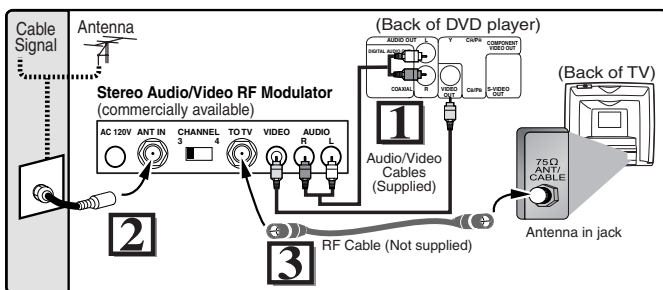

Hint

- The quality of picture may become poor if the unit is connected to an RF Modulator.

If you need additional operating assistance after reading this owner's manual, please call

TOLL FREE : 1-800-968-3429

or visit our web site at

<http://www.SylvaniaConsumerElectronics.com>

Table of Contents

Precautions

| | |
|--|---|
| Laser Safety | 2 |
| ■ Important Safeguards | 3 |
| Installation Location | 4 |
| Avoid the Hazards of Electrical Shock and Fire | 4 |
| Moisture Condensation Warning | 4 |
| About Copyright | 4 |
| Notice for Progressive Scan Outputs | 4 |
| Symbols Used in This Manual | 4 |
| Maintenance | 4 |
| ■ About the Discs | 5 |
| Playable Discs | 5 |
| Unplayable Discs | 5 |

Setup

| | |
|---|---|
| ■ Connections | 6 |
| Connection to a TV | 6 |
| Connection to an Audio System | 7 |
| Rear Terminals | 7 |
| ■ About the Remote Control | 8 |
| Remote Control | 8 |
| Installing the Batteries for the Remote Control | 8 |

Functions

| | |
|---|----|
| ■ Playback | 9 |
| ■ MP3 Playback | 10 |
| ■ On-Screen Display | 10 |
| ■ Search Function | 11 |
| Track Search | 11 |
| Title / Chapter Search | 11 |
| Time Search | 11 |
| ■ Marker Setup | 11 |
| ■ Repeat / Random / Programmed Playback | 12 |
| Repeat Playback | 12 |
| Repeat A-B Playback | 12 |
| Random Playback | 12 |
| Programmed Playback | 12 |
| ■ Special Settings | 13 |
| Subtitle Language | 13 |
| Audio Language | 13 |
| Camera Angles | 13 |
| Black Level Setting | 13 |
| Stereo Sound Mode | 13 |
| Virtual Surround | 13 |
| ■ DVD Setup | 14 |
| LANGUAGE Setting | 14 |
| DISPLAY Setting | 15 |
| AUDIO Setting | 15 |
| PARENTAL Setting | 16 |
| OTHERS Setting | 16 |
| Reset to the Default Setting (Except for PARENTAL Setting) | 17 |

Information

| | |
|--------------------------------|----|
| ■ Troubleshooting Guide | 17 |
| ■ Specifications | 18 |
| ■ Language List | 18 |
| ■ Limited Warranty | 18 |

Español19

Quick Use Guide20

Precautions

Setup

Functions

Information

Español

Precautions

WARNING: TO REDUCE THE RISK OF FIRE OR ELECTRIC SHOCK, DO NOT EXPOSE THIS APPLIANCE TO RAIN OR MOISTURE.



CAUTION
RISK OF ELECTRIC SHOCK
DO NOT OPEN



The lightning flash with arrowhead symbol, within an equilateral triangle, is intended to alert the user to the presence of uninsulated "dangerous voltage" within the product's enclosure that may be of sufficient magnitude to constitute a risk of electric shock to persons.



The exclamation point within an equilateral triangle is intended to alert the user to the presence of important operating and maintenance (servicing) instructions in the literature accompanying the appliance.

CAUTION:

TO REDUCE THE RISK OF ELECTRIC SHOCK, DO NOT REMOVE COVER (OR BACK). NO USER SERVICEABLE PARTS INSIDE. REFER SERVICING TO QUALIFIED SERVICE PERSONNEL.

Laser Safety

This unit employs a laser. Only a qualified service person should remove the cover or attempt to service this device, due to possible eye injury.

CAUTION: USE OF CONTROLS OR ADJUSTMENTS OR PERFORMANCE OF PROCEDURES OTHER THAN THOSE SPECIFIED HEREIN MAY RESULT IN HAZARDOUS RADIATION EXPOSURE.

CAUTION: VISIBLE AND INVISIBLE LASER RADIATION WHEN OPEN AND INTERLOCK DEFEATED. DO NOT STARE INTO BEAM.

LOCATION: INSIDE, NEAR THE DECK MECHANISM.

FCC WARNING- This equipment may generate or use radio frequency energy. Changes or modifications to this equipment may cause harmful interference unless the modifications are expressly approved in the manual. The user could lose the authority to operate this equipment if an unauthorized change or modification is made.

RADIO-TV INTERFERENCE

This equipment has been tested and found to comply with the limits for a Class B digital device, pursuant to Part 15 of the FCC Rules. These limits are designed to provide reasonable protection against harmful interference in a residential installation. This equipment generates, uses, and can radiate radio frequency energy and, if not installed and used in accordance with the instructions, may cause harmful interference to radio communications. However, there is no guarantee that interference will not occur in a particular installation. If this equipment does cause harmful interference to radio or television reception, which can be determined by turning the equipment off and on, the user is encouraged to try to correct the interference by one or more of the following measures:

- 1) Reorient or relocate the receiving antenna.
- 2) Increase the separation between the equipment and receiver.
- 3) Connect the equipment into an outlet on a circuit different from that to which the receiver is connected.
- 4) Consult the dealer or an experienced radio/TV technician for help.

This Class B digital apparatus complies with Canadian ICES-003.

Cet appareil numérique de la classe B est conforme à la norme NMB-003 du Canada.

CAUTION: TO PREVENT ELECTRIC SHOCK, MATCH WIDE BLADE OF PLUG TO WIDE SLOT, FULLY INSERT.

ATTENTION: POUR ÉVITER LES CHOC ÉLECTRIQUES, INTRODUIRE LA LAME LA PLUS LARGE DE LA FICHE DANS LA BORNE CORRESPONDANTE DE LA PRISE ET POUSSER JUSQU'AU FOND.

A NOTE ABOUT RECYCLING

This product's packaging materials are recyclable and can be reused. Please dispose of any materials in accordance with your local recycling regulations.

Batteries should never be thrown away or incinerated but disposed of in accordance with your local regulations concerning chemical wastes.

Make your contribution to the environment!!!

- Used up batteries do not belong in the dust bin.
- You can dispose of them at a collection point for used up batteries or special waste. Contact your council for details.



For Customer Use:

Read carefully the information located at the bottom of this unit and enter below the Serial No. Retain this information for future reference.

Model No. _____

Serial No. _____

IMPORTANT SAFEGUARDS

- 1) Read Instructions - All the safety and operating instructions should be read before the product is operated.
- 2) Retain Instructions - The safety and operating instructions should be retained for future reference.
- 3) Heed Warnings - All warnings on the product and in the operating instructions should be adhered to.
- 4) Follow Instructions - All operating and use instructions should be followed.
- 5) Cleaning - Unplug this product from the wall outlet before cleaning. Do not use liquid cleaners or aerosol cleaners. Use a damp cloth for cleaning.
- 6) Attachments - Do not use attachments not recommended by the product manufacturer as they may cause hazards.
- 7) Water and Moisture - Do not use this product near water - for example, near a bath tub, wash bowl, kitchen sink, or laundry tub; in a wet basement; or near a swimming pool; and the like.
- 8) Accessories - Do not place this product on an unstable cart, stand, tripod, bracket, or table. The product may fall, causing serious injury to a child or adult, and serious damage to the product. Use only with a cart, stand, tripod, bracket, or table recommended by the manufacturer, or sold with the product. Any mounting of the product should follow the manufacturer's instructions, and should use a mounting accessory recommended by the manufacturer.

PORTABLE CART WARNING
(Symbol provided by RETAC)



S3125A
- 9) A product and cart combination should be moved with care. Quick stops, excessive force, and uneven surfaces may cause the product and cart combination to overturn.
- 10) Ventilation - Slots and openings in the cabinet are provided for ventilation and to ensure reliable operation of the product and to protect it from overheating, and these openings must not be blocked or covered. The openings should never be blocked by placing the product on a bed, sofa, rug, or other similar surface. This product should not be placed in a built-in installation such as a bookcase or rack unless proper ventilation is provided or the manufacturer's instructions have been adhered to.
- 11) Power Sources - This product should be operated only from the type of power source indicated on the marking label. If you are not sure of the type of power supply to your home, consult your product dealer or local power company. For products intended to operate from battery power, or other sources, refer to the operating instructions.
- 12) Grounding or Polarization - This product may be equipped with a polarized alternating-current line plug (a plug having one blade wider than the other). This plug will fit into the power outlet only one way. This is a safety feature. If you are unable to insert the plug fully into the outlet, try reversing the plug. If the plug should still fail to fit, contact your electrician to replace your obsolete outlet. Do not defeat the safety purpose of the polarized plug.
- 13) Power-Cord Protection - Power-supply cords should be routed so that they are not likely to be walked on or pinched by items placed upon or against them, paying particular attention to cords at plugs, convenience receptacles, and the point where they exit from the product.
- 14) Lightning - For added protection for this product during a lightning storm, or when it is left unattended and unused for long periods of time, unplug it from the wall outlet. This will prevent damage to the product due to lightning and power-line surges.
- 15) Power lines - An outside antenna system should not be located in the vicinity of overhead power lines or other electric light or power circuits, or where it can fall into such power lines or circuits. When installing an outside antenna system, extreme care should be taken to keep from touching such power lines or circuits as contact with them might be fatal.
- 16) Overloading - Do not overload wall outlets, extension cords, or integral convenience receptacles as this can result in a risk of fire or electric shock.
- 17) Object and Liquid Entry - Never push objects of any kind into this product through openings as they may touch dangerous voltage points or short-out parts that could result in a fire or electric shock. Never spill liquid of any kind on the product.
- 18) Servicing - Do not attempt to service this product yourself as opening or removing covers may expose you to dangerous voltage or other hazards. Refer all servicing to qualified service personnel.
- 19) Damage Requiring Service - Unplug this product from the wall outlet and refer servicing to qualified service personnel under the following conditions:
 - a) When the power-supply cord or plug is damaged,
 - b) If liquid has been spilled, or objects have fallen into the product,
 - c) If the product has been exposed to rain or water,
 - d) If the product does not operate normally by following the operating instructions. Adjust only those controls that are covered by the operating instructions as an improper adjustment of other controls may result in damage and will often require extensive work by a qualified technician to restore the product to its normal operation,
 - e) If the product has been dropped or damaged in any way.
 - f) When the product exhibits a distinct change in performance - this indicates a need for service.
- 20) Replacement Parts - When replacement parts are required, be sure the service technician has used replacement parts specified by the manufacturer or have the same characteristics as the original part. Unauthorized substitutions may result in fire, electric shock, or other hazards.
- 21) Safety Check - Upon completion of any service or repairs to this product, ask the service technician to perform safety checks to determine that the product is in proper operating condition.
- 22) Heat - The product should be situated away from heat sources such as radiators, heat registers, stoves, or other products (including amplifiers) that produce heat.

Installation Location

For safety and optimum performance of this unit:

- Do not stand the unit up vertically. Install the unit in a horizontal and stable position. Do not place anything directly on top of the unit. Do not place the unit directly on top of the TV.
- Shield it from direct sunlight and keep it away from sources of intense heat. Avoid dusty or humid places. Avoid places with insufficient ventilation for proper heat dissipation. Do not block the ventilation holes on the sides of the unit. Avoid locations subject to strong vibration or strong magnetic fields.
- Be sure to remove the disc and unplug the AC power cord from the output before carrying the unit.

Avoid the Hazards of Electrical Shock and Fire

- Do not handle the power cord with wet hands.
- Do not pull on the power cord when disconnecting it from AC wall outlet. Grasp it by the plug.
- If, by accident, water is spilled on this unit, unplug the power cord immediately and take the unit to our Authorized Service Center for servicing.

Moisture Condensation Warning

Moisture condensation may occur inside the unit when it is moved from a cold place to a warm place, or after heating a cold room or under conditions of high humidity. Do not use this unit at least for 2 hours until its inside gets dry.

About Copyright

Unauthorized copying, broadcasting, public performance and lending of discs are prohibited. This product incorporates copyright protection technology that is protected by U.S. patents and other intellectual property rights. Use of this copyright protection technology must be authorized by Macrovision, and is intended for home and other limited viewing uses only unless otherwise authorized by Macrovision. Reverse engineering or disassembly is prohibited.

Notice for Progressive Scan Outputs

Consumers should note that not all high definition television sets are fully compatible with this product and may cause artifacts to be displayed in the picture. In case of picture problems with 525 progressive scan output, it is recommended that the user switch the connection to the 'standard definition' output. If there are questions regarding your TV set compatibility with this 525p DVD player, please contact our customer service center.

Symbols Used in This Manual

The following symbols appear in some headings in this manual.



: Description refers to playback of DVD-Video discs.



: Description refers to playback of Audio CDs.



: Description refers to playback of MP3 files.

Maintenance

SERVICING

- Please refer to relevant topics on the "Troubleshooting Guide" on page 17 before returning the product.
- If this unit becomes inoperative, do not try to correct the problem by yourself. There are no user-serviceable parts inside. Turn off, unplug the power plug, and please call our help line mentioned on the front page to locate an Authorized Service Center.

CLEANING THE CABINET

- Use a soft cloth slightly moistened with a mild detergent solution. Do not use a solution containing alcohol, spirits, ammonia or abrasive.

CLEANING DISCS

- When a disc becomes dirty, clean it with a cleaning cloth. Wipe the disc from the center out. Do not wipe in a circular motion.
- Do not use solvents such as benzine, thinner, commercially available cleaners, detergent, abrasive cleaning agents or antistatic spray intended for analog records.

CLEANING THE DISC LENS

- If this unit still does not perform properly although you refer to the relevant sections and to "Troubleshooting Guide" in this Owner's Manual, the laser optical pickup unit may be dirty. Consult your dealer or an Authorized Service Center for inspection and cleaning of the laser optical pickup unit.

DISC HANDLING

- When you handle a disc hold it by its edge and try not to touch the surface of the disc.
- Always store a disc in its protective case when it is not used.

Manufactured under license from Dolby Laboratories. "Dolby" and the double-D symbol are trademarks of Dolby Laboratories.

About the Discs

Playable Discs

| Playable discs | Mark (logo) | Region code | Recorded signals | Disc size | Disc types |
|--|-------------|-------------|-----------------------|--------------|--|
| DVD-Video * 1, 2, 4, 6 | | | Digital video (MPEG2) | 12 cm or 8cm | <p>Example Title 1 Title 2 Chapter 1 Chapter 2 Chapter 3 Chapter 4 Chapter 1 Chapter 2</p> |
| DVD-RW DVD-R * 1, 3, 4, 5, 6, 7, 9, 10 | | - | | | |
| DVD+RW DVD+R * 1, 3, 4, 5, 6, 8 | | - | | | |
| Audio CD * 4, 6 | | - | Digital audio | 12 cm or 8cm | <p>Example Track 1 Track 2 Track 3 Track 4 Track 5 Track 6</p> |
| CD-RW CD-R * 4, 5, 6, 9, 10 | | - | Digital audio or MP3 | | <p>Example Group 1 Group 2 Track 1 Track 2 Track 3 Track 4 Track 5 Track 6</p> |

DVD is a trademark of DVD Format/Logo Licensing Corporation.

If you cannot play back a disc which bears one of the marks above, check the following notes.

- *1: This unit conforms to the NTSC color system. Discs recorded in other color systems such as PAL cannot be played back.
- *2: Certain DVD-Video discs do not operate as described in this manual due to the intentions of the disc's producers.
- *3: Discs recorded in the VR (Video Recording) format cannot be played back.
- *4: Scratched or stained discs may not be played back.
- *5: Some discs cannot be played back because of incompatible recording conditions, characteristics of the recorder or special properties of discs.
- *6: You can play back discs which bear the marks above. If you use nonstandardized discs, this unit may not play them back. Even if they are played back, the sound or video quality will be compromised.
- *7: You may play back the unfinalized DVD-R/RW disc recorded in the video format on our brand's DVD recorder. However, depending on the recording status of a disc, the disc may not be played back at all or normally (the picture or sound may not be smooth, etc.). In this case, you need to finalize the disc with the DVD recorder. Refer to the manual accompanying the DVD recorder.
- *8: Only the discs recorded in the video format and finalized can be played back. Unfinalized discs cannot be played back. Depending on the recording status of a disc, the disc may not be played back at all or normally (the picture or sound may not be smooth, etc.).
- *9: If there is too much recording space left on a disc (the used portion is less than 55 mm across), it may not play back properly.
- *10: Do not glue paper or put stickers on to the disc. These may damage the disc, and the unit may not read it correctly.

Unplayable Discs

- **NEVER play back the following discs. Otherwise, malfunction may result!**
DVD-RAM / CD-I / Photo CD / Video CD / DVD with region codes other than 1 or ALL
DTS-CD / DVD-ROM for personal computers / CD-ROM for personal computers
- **On the following disc, the sound MAY NOT be heard.**
Super Audio CD
NOTE: Only the sound recorded on the normal CD layer can be delivered.
The sound recorded on the high density Super Audio CD layer cannot be delivered.
- *Any other discs without compatibility indications.*

Setup

Connections

If your TV has AUDIO/VIDEO input jacks, see the following instructions. If not, see the section "Connecting to RF Modulator" on the front page.

Connection to a TV

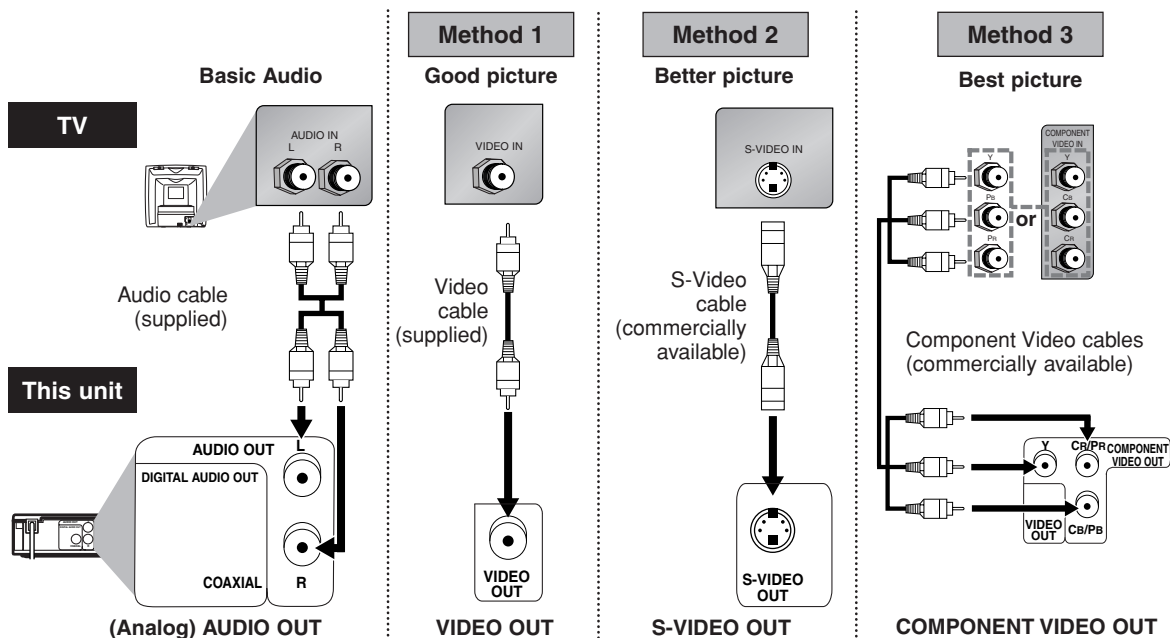

Hint

- Connect this unit directly to the TV. If the Audio/Video cables are connected to a VCR, pictures may be distorted due to the copy protection system.
- When progressive scanning mode is selected, no video signal will be output from the VIDEO OUT or S-VIDEO OUT jack.

If your TV is compatible with 525p (480p) progressive scanning and you want to enjoy that high quality picture:

You must select the connection Method 3 above and progressive scanning mode. To set the mode, press and hold [PLAY ►] on the front panel for more than 5 seconds, so that PROGRESSIVE SCAN indicator will light up.

If your TV is not compatible with progressive scanning:

Use this unit in interlace mode. Make sure that PROGRESSIVE SCAN indicator is off. If not, press and hold [PLAY ►] on this unit for more than 5 seconds, so that PROGRESSIVE SCAN indicator of this unit will light off.

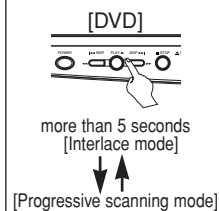

After you have completed connections

- Hit the input selector button (usually TV/VIDEO, INPUT or AUX) on your TV to switch an appropriate external input channel (usually near channel 0) for viewing the picture from this unit. If the picture does not appear, also refer to the manual accompanying your TV.

INPUT MODES FOR COMMON TV BRANDS (Example)

- Listed below are inputs for common brand name TV's.

| | |
|----------------|-------------------------------------|
| Admiral: | AUX |
| Curtis Mathis: | LINE1, LINE2, 00, 90, 91, 92, 93 |
| GE: | INPUT, TV/VCR, 00, 90, 91, 92, 93 |
| Hitachi: | INPUT, AUX |
| JVC: | A/V CHANNEL, INPUT1, SVIDEO, INPUT2 |
| Kenwood: | AUX |
| LXI-Series: | 00 |
| Magnavox: | AUX CHANNEL |
| Panasonic: | TV/VIDEO |
| RCA: | INPUT, TV/VCR, 00, 90, 91, 92, 93 |

| | |
|----------|------------------------|
| Samsung: | TV/VIDEO |
| Sanyo: | VIDEO |
| Sharp: | 00 |
| Sony: | VIDEO1, VIDEO2, VIDEO3 |
| Toshiba: | TV/GAME |
| Zenith: | 00 |

Connection to an Audio System

Method 1

Stereo system

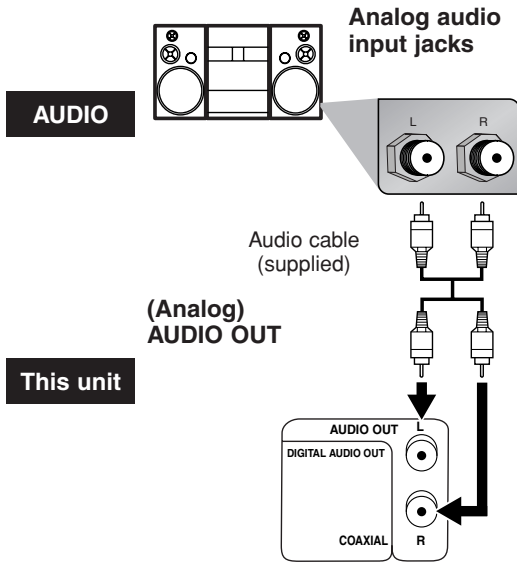

Method 2

Dolby Digital decoder, MD deck or DAT deck

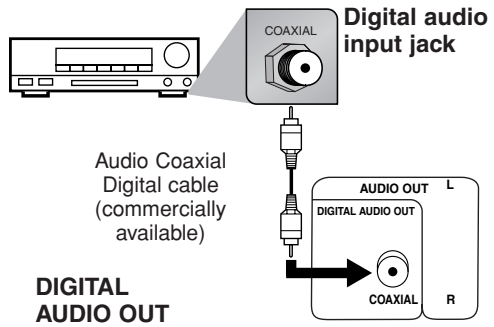

| Connection | Setting | SETUP > AUDIO menu > |
|--|---------|----------------------|
| | | DOLBY DIGITAL |
| Connecting to a Dolby Digital decoder for Dolby Digital audio output. | | BITSTREAM |
| Connecting to the other equipment (an MD deck or DAT deck etc.) without Dolby Digital decoder. | | PCM |

* To complete these settings, refer to pages 14-15.

| Connection | Setting | SETUP > AUDIO menu > |
|------------------------------|---------|----------------------|
| | | DOLBY DIGITAL |
| Connecting to Stereo System. | | PCM |

* To complete these settings, refer to pages 14-15.

Hint

- Playing a DVD using incorrect settings may generate noise distortion and may also damage the speakers.

Hint

- The audio source on a disc in a Dolby Digital 5.1 channel surround format cannot be recorded as digital sound by an MD or DAT deck.
- By hooking this unit up to a Multi-channel Dolby Digital decoder, you can enjoy high-quality Dolby Digital 5.1 channel surround sound as heard in the movie theaters.
- Playing a DVD using incorrect settings may generate noise distortion and may also damage the speakers.

Rear Terminals

AUDIO OUT jacks

Connect the supplied audio cables here through the audio in jacks of a television or other audio equipment.

COMPONENT VIDEO OUT jacks

Connect optional component video cables here through the component video in jacks of a television.

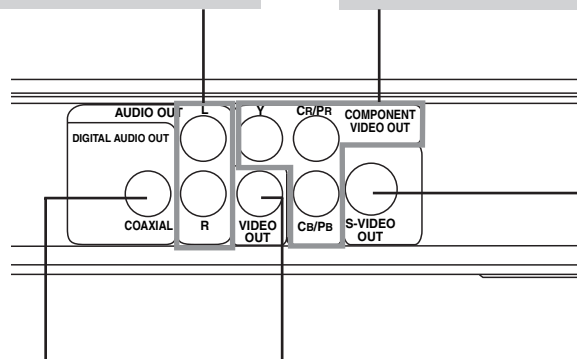

COAXIAL jack

Connect an optional coaxial digital audio cable here through the coaxial digital audio in jack of a decoder or audio receiver.

VIDEO OUT jack

Connect the supplied yellow video cable here through the TV's video in jack.

S-VIDEO OUT jack

Connect an optional S-Video cable here through the S-video in jack of a television.

About the Remote Control

Remote Control

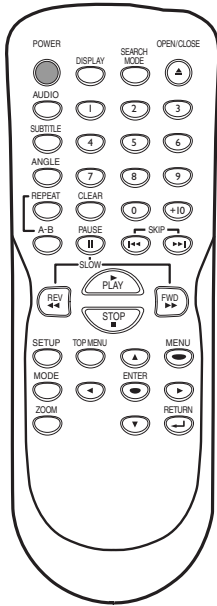

Installing the Batteries for the Remote Control

Install two AA batteries (supplied) matching the polarity indicated inside battery compartment of the remote control.

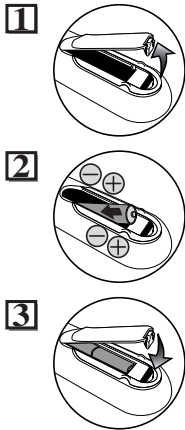

Keep in mind the following when using the remote control:

- Make sure that there is no obstacle between the remote control and the remote sensor on the unit.
- The maximum operable ranges from the unit are as follows.
 - **Beeline:** approx. 23 feet (7m)
 - **Either side of the center:** approx. 16 feet (5m) within 30°
 - **Above:** approx. 16 feet (5m) within 15°
 - **Below:** approx. 10 feet (3m) within 30°

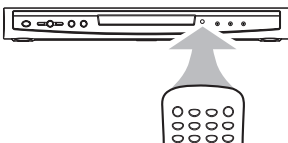

| Button (Alphabetical order) | Disc | DVD-V | CD MP3 |
|--------------------------------|------|--|--|
| 1 2 3 4 5 6 7 8 9 0 | | • To select chapter or title directly. | • To select track directly. |
| ENTER ← → | | • To move the cursor and determine its position. | • To move the cursor and determine its position. |
| A-B | | • To repeat between your chosen point A and B. | • To repeat between your chosen point A and B. (CD) |
| ANGLE | | • To select camera angles on a disc. | — |
| AUDIO | | • To select audio languages on a disc. | • To select STEREO, L-ch or R-ch. (CD) |
| CLEAR | | • To clear the markers. • To clear the numbers entered incorrectly. • To cancel the point for A-B repeat. | • To clear the markers. (CD) • To remove status number in program input. • To clear the numbers entered incorrectly. • To cancel the point for A-B repeat. (CD) |
| DISPLAY | | • To display the current disc mode. | • To display the current disc mode. |
| REV ← → FWD | | • To search forward/backward through a disc. • To begin slow forward /reverse playback during the pause mode. | • To search forward/backward through a disc. |
| MENU | | • To call up the Menu on a disc. | • To call up the file list. (MP3) |
| MODE | | • To set black level on/off. • To set virtual surround on/off. | • To arrange the playing order or play randomly. • To set virtual surround on/off. |
| OPEN/CLOSE | | • To open or close the disc tray. | • To open or close the disc tray. |
| PAUSE | | • To pause disc playback. • To advance playback one frame at a time. | • To pause disc playback. |
| PLAY | | • To begin disc playback. | • To begin disc playback. |
| POWER | | • To turn the unit on or off. | • To turn the unit on or off. |
| REPEAT | | • To play a chapter or title repeatedly. | • To play a track or disc repeatedly. (CD) • To play a track, group or disc repeatedly. (MP3) |
| RETURN | | • To return to the previous operation in menu. | • To return to the previous operation in menu. |
| SEARCH MODE | | • To search chapter, title or time. • To set or search the markers. | • To search track. • To search time. (CD) • To set or search the markers. (CD) |
| SETUP | | • To call up the DVD setup menu. | • To call up the DVD setup menu. |
| SKIP | | • To skip chapters. | • To skip tracks. |
| STOP | | • To stop playback. | • To stop playback. |
| SUBTITLE | | • To select subtitles on a disc. | — |
| TOP MENU | | • To call up the Top Menu on a disc. | • To return to the top file of the highest hierarchy in the program and file list. (MP3) |
| ZOOM | | • To magnify part of a picture. (x2/x4) | — |

Functions

Operations described after this section are mainly based on the remote control use. Some operations can be carried out on main unit.

Playback

Before: Turn on the TV, amplifier and any other equipments which are connected to this unit. Make sure the TV and audio receiver (commercially available) are set to the correct channel.

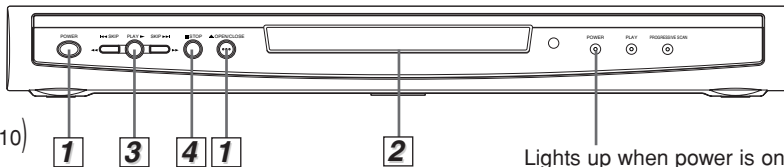

Lights up when power is on.

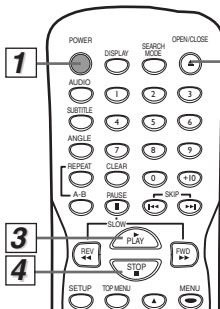
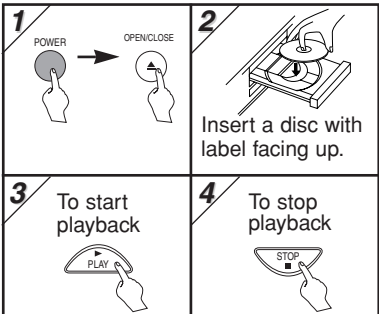

Hint

- When you play an MP3 file, details on page 10.
- A "prohibited icon" may appear at the top-right on the TV screen when the operation is prohibited by the disc or this unit.
- Some DVDs may start playback from title 2 or 3 due to specific programs.
- During the playback of a two-layered disc, pictures may stop for a moment. This happens while the 1st layer is being switched to the 2nd layer. This is not a malfunction.

TIP:

You can change the On-Screen language in "PLAYER MENU" setting. (Refer to page 14.)

DVD menu

Some discs contain menus which allow you to customize DVD playback. Press [▲/▼/◀/▶] to select an item, then press [ENTER] (or [PLAY ►]) to select.

Calling Up a Menu Screen during Playback

- Hit [MENU] to call up the DVD menu.
- Hit [TOP MENU] to call up the title menu.

Hint

- Menu operations may vary depending on the disc. Refer to the manual accompanying the disc for more details.

Resume

Hit [STOP ■]. Resume message will appear on the TV screen.

Hit [PLAY ►], playback will resume from the point at which playback was stopped.

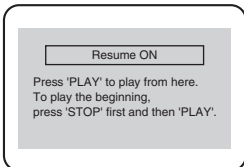

<Example : DVD>

Hint

- To cancel resume, hit [STOP ■] one more time during the stop mode.
- For MP3, playback will resume from the beginning of the track at which playback was stopped.
- The resume information will be kept even when the power is turned off.

Paused and Step-by-Step Playback



Hit [PAUSE ||] during playback. To continue playback, hit [PLAY ►].



The disc goes forward by one frame each time [PAUSE ||] is hit during the pause mode. To continue playback, hit [PLAY ►].

Hint

- On DVDs, set "STILL MODE" to "FIELD" in the Display menu if pictures in the pause mode are blurred. (Refer to pages 14-15.)

To use [SKIP ◀◀], [▶▶ SKIP] on the Main Unit



Hit once to skip chapters or tracks to a desired point. Press and hold to change forward or reverse playback speed.

Fast Forward/Reverse Search



Press [REV ◀◀] or [FWD ▶▶] repeatedly during playback to select the required forward or reverse speed.

To continue playback, hit [PLAY ►].

Hint

- For DVDs, fast forward or reverse search speed is different depending on the disc. Approximate speed is 1(x2), 2(x8), 3(x20), 4(x50) and 5(x100).
- For Audio CDs, approximate speed is 1(x2), 2(x8) and 3(x30).
- For MP3, approximate speed is 1(x2), 2(x8), 3(x30).

Slow Forward/Slow Reverse



Press [REV ◀◀] or [FWD ▶▶] repeatedly during the pause mode to select the required forward or reverse speed.

To continue playback, hit [PLAY ►].

Hint

- Slow forward or reverse speed is different depending on the disc. Approximate speed is 1(1/16), 2(1/8) and 3(1/2).
- Set "STILL MODE" to "FIELD" in the Display menu if pictures in the slow playback mode are blurred. (Refer to pages 14-15.)

Zoom



Hit [ZOOM] repeatedly during playback to select the required zoom factor: x2, x4 or OFF.



Press [▲/▼/◀/▶] to slide the zoomed picture across the screen.

To exit zoom function, hit [ZOOM] repeatedly to select OFF.

Hint

- Zooming function does not work while the disc menu is showing up.
- x4 zoom is not available on some discs.
- The picture may be distorted when you press [PAUSE ||] or [REV ◀◀] repeatedly in the zoom mode.
- It may take several seconds to slide the zoomed picture.

MP3 Playback

MP3 is a method of compressing files. You can copy MP3 files on CD-R/RWs from the computer and play the files on this unit.



Insert an MP3-format disc, then hit **[MENU]** to call up the file list on the TV screen.

1 MENU

When selecting the folder:

- Hit **[▶]** when you want to go to the next hierarchy.
- Hit **[◀]** when you want to go back to the previous hierarchy (except for the top hierarchy).

ENTER or PLAY

2

Refer to "Resume" on page 15.

Hint

- Some selections may take a while to be recognized.
- Hit **[TOP MENU]** to return to the first item.
- Folders are known as Groups; files are known as Tracks.
- MP3 files are accompanied by **[▶]** icon.
- Folders are accompanied by **[□]** icon.
- A maximum of 255 folders can be recognized.
- A maximum of 999 files can be recognized.
- Up to 8 hierarchies can be created.

This player recommends the files recorded under the following circumstances:

- Sampling frequency: 44.1kHz or 48kHz
- Constant bit rate: 32kbps ~ 320kbps
- For MP3 file recorded in Variable Bit Rate(VBR), the unit may not display the actual elapsed time.

On-Screen Display

You can check the information about the current disc by hitting **[DISPLAY]** on the remote control.

Functions

1 **[DVD]** 11/16 0:00:00 - 0:03:30

- Angle icon, appears only when available on the DVD
- Current playback status
- Remaining time of the current chapter
- Elapsed time of the current chapter
- CH(Chapter): Current chapter number / Total chapters

2 **[DVD]** 1/3 0:00:00 - 1:23:45

- Remaining time of the current title
- Elapsed time of the current title
- TT(Title): Current title number / Total titles

3 **[DVD]** L0 L1

- Layer numbers, appears only when playing a two-layered Disc
L0: Layer 0 is playing
L1: Layer 1 is playing
- Current repeat setting appears only when the repeat setting is active
◁C: Chapter repeat / ▷T: Title repeat / A◁B: A-B repeat
- BIT RATE: The amount of audio and video data currently being read

4 **[DVD]**

1 **[CD]** 4/12 0:03:21 - 0:02:15

- Current playback status
- Remaining time of the current track
- Elapsed time of the current track
- TR(Track): Current track number / Total tracks

2 **[CD]** 4/12 0:13:45 - 0:45:40

- ALL: Current track number / Total tracks
- Current repeat setting appears only when the repeat setting is active
◁T: Track repeat
◁A: All Tracks repeat
A◁B: A-B repeat
- Remaining time of the entire disc
- Elapsed time of the entire disc

3 **[CD]**

Hint

- When you are playing a disc in PROGRAM or RANDOM mode, **[TR]** PROGRAM (or RANDOM) will be displayed instead of **[2]**.

1 **[MP3]** TRACK 01

- Current playback status
- The name of the file currently in play will be displayed.

2 **[MP3]** 1/36 0:01:15

- TR(Track): Current track number / Total tracks
- Current repeat setting, if active
◁T: Track repeat
◁G: Group (folder) repeat
◁A: Disc repeat
- Elapsed playing time of the current track

3 **[MP3]** PROGRAM or **[MP3]** RANDOM

(Only when you are playing a disc in PROGRAM or RANDOM mode.)

4 **[MP3]**

Search Function

Track Search



Using [SEARCH MODE]

1

2

Within 30 seconds.

- For the disc with less than 10 tracks, hit the track number directly.
- For discs with more than 10 but less than 99 tracks, to play single-digit track, hit [0] first, then the track number (e.g. for track 3, hit [0],[3]). To play a double-digit track, hit the track number.
- For discs with more than 100 tracks, to play a single or a double-digit track, hit [0] first, then the track number (e.g. for track 3, hit [0],[0],[3]), and for track 26, hit [0],[2],[6]). To play a triple-digit track, hit the track number.

Using [SKIP <<<, >>>]

1

Current Track (TR)

TR 1 TR 2 TR 3 TR 4

SKIP <<< >>> SKIP

Hint

- [+10] button can also bring the Track Search display, except for the disc with less than 10 tracks. For such a disc, track search can be done by just hitting the track number.

Title / Chapter Search



Using [SEARCH MODE]

1

Hit once for the Chapter Search.
Hit twice for the Title Search.

2

Within 30 seconds.

Using [SKIP <<<, >>>]

1

SKIP <<< or >>> SKIP

Current Chapter (CH)

CH 1 CH 2 CH 3 CH 4

or

Current Title (T)

T 1 T 2 T 3 T 4

SKIP <<< or >>> SKIP

(If the disc has no chapters)

Hint

- Depending on the disc being played, this function can also be performed by directly entering the desired chapter number with the **Number buttons**. Refer to the manual accompanying the disc.
- For CDs and MP3, Track Search is not available for Programmed or Random Playback.

Time Search



1

Hit repeatedly until the Time Search display appears.

2

Within 30 seconds.

Hint

- When there is no need to enter a number, "0" appears automatically. For example, "0:0:..." appears in the Time Search display if the total time of the title or track is less than 10 minutes.
- Hit [CLEAR] to erase the incorrect input at step 2).

Marker Setup



This feature allows you to assign a specific point on a disc to be called back later.

To set a marker

1

Hit repeatedly until the marker display appears.

2

3

ENTER

To return to the marker later

1

Hit repeatedly until the marker display appears.

2

3

ENTER

at the desired marker

- Playback will restart from the specific point which you set.

To exit the marker display

1

Hint

- The Marker display will disappear in about 30 seconds when there is no output.
- To clear a marker, select the marker to be cleared at step 2) in the section "To set a marker" or "To return to the marker later" and then hit [CLEAR].
- Opening the disc tray or turning off the power will erase all markers.
- Selecting "AC" at step 2) in the section "To set a marker" or "To return to the marker later" will also erase all markers.

Repeat / Random / Programmed Playback

Repeat Playback



Repeat function is available only during playback.

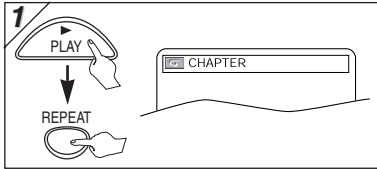

Each time you hit [REPEAT], repeat function changes as example below.



- ▶ **CHAPTER** (current chapter repeat)
- ▶ **TITLE** (current title repeat)
- ▶ **OFF** (repeat off)



- ▶ **TRACK** (current track repeat)
- ▶ **ALL** (entire disc repeat)
- ▶ **OFF** (repeat off)



- ▶ **TRACK** (current track repeat)
- ▶ **GROUP** (current group repeat)
- ▶ **ALL** (entire disc repeat)
- ▶ **OFF** (repeat off)

Hint

- Repeat setting will be cleared when moving to another title, chapter, track or group.
- Repeat playback may not function with some discs or during repeat A-B playback.

Repeat A-B Playback

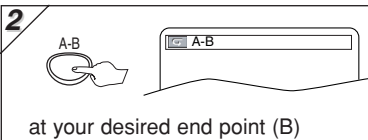
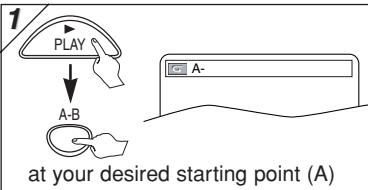

- Point B should be in the same title or track as point A.

Hint

- To exit the sequence, hit [A-B] so that OFF appears.
- To cancel Point A, hit [CLEAR].
- This function does not work in the other repeat modes.

Random Playback

This function shuffles the playing order of tracks instead of playback in the sequence.

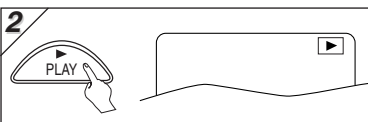
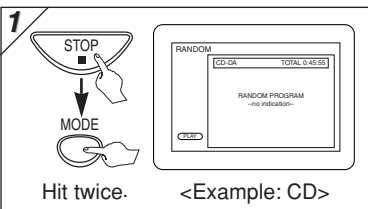

Hint

- To repeat the current track in the random selections, hit [REPEAT] repeatedly until "TRACK" appears during playback.
- To repeat the entire random selections, hit [REPEAT] repeatedly until "ALL" appears during playback.

Programmed Playback



You may determine the order in which tracks will play.

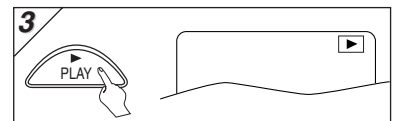
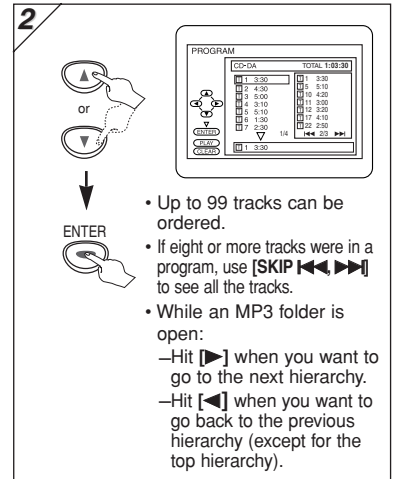
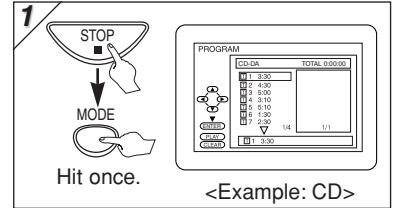

Hint

- Hit [CLEAR] at step 2) to erase the most recently entered track.
- To erase all programmed tracks at once, select "ALL CLEAR" and hit [ENTER] at step 2).
- While a program is being played back, [STOP] works as follows:
 - ⇒ Hit [STOP] and [PLAY] next, so that the programmed playback restarts. (CD playback restarts from the current point. MP3 playback restarts from the beginning of the current track.)
 - ⇒ Hit [STOP] twice and [PLAY] next, so that playback restarts from the first track in the original order. However, your programmed playback can be restarted when you follow the above steps. (Your programs are still stored until either the disc tray is open or power is turned off.)
- To repeat the current track in the program, hit [REPEAT] repeatedly until "TRACK" appears during playback.
- To repeat the entire program, hit [REPEAT] repeatedly until "ALL" appears during playback.

Special Settings

Subtitle Language



This unit allows you to select a subtitle language (if available) during DVD playback.

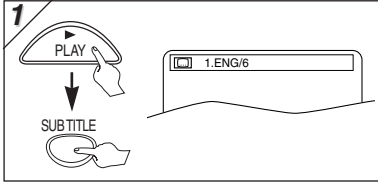

Each time you hit [SUBTITLE], subtitle language changes as example below.

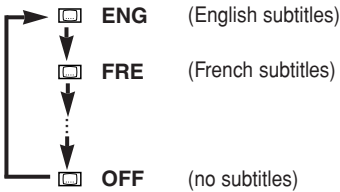

To set subtitle ON/OFF

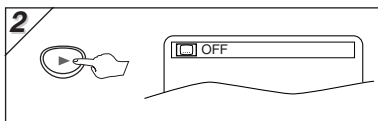
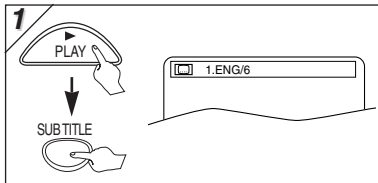

Hint

- If your language is not shown after pressing [AUDIO] or [SUBTITLE] several times, the disc may not have that language. However, some discs allow audio language or subtitle language setting on the disc menu. (Operation varies depending on the disc, so refer to the manual along with the disc.)
- When "NOT AVAILABLE" appears on the TV screen, it means no subtitle is recorded on the scene.
- If you choose a language that has three-letter-language code, the code will be displayed every time you change the subtitle language setting. If you choose any other languages, '---' will be displayed instead. (Refer to page 18.)

Audio Language



This unit allows you to select an audio language (if multiple languages are available on disc) during DVD playback.

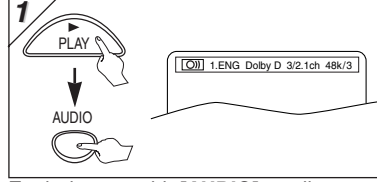

Each time you hit [AUDIO], audio language changes as example below.

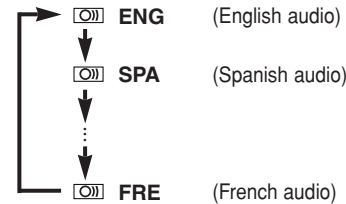

Camera Angles



Some DVD discs may contain scenes which have been shot simultaneously from various angles. You can change the camera angle if the (ANGLE) icon appears on the screen. If the "ANGLE ICON" setting is "OFF" in the OTHERS menu, the (ANGLE) icon will not appear. (Refer to pages 14-16.)

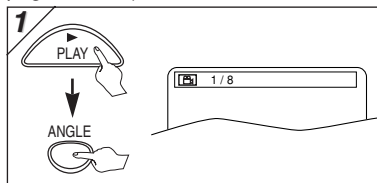

Black Level Setting



Adjust the Black Level Setting to make the dark areas of the TV picture brighter.

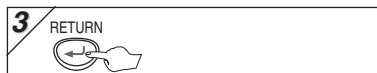
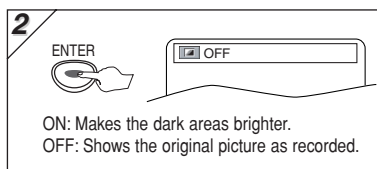
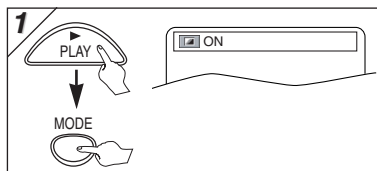

Stereo Sound Mode



This unit allows you to select a sound mode during CD playback.

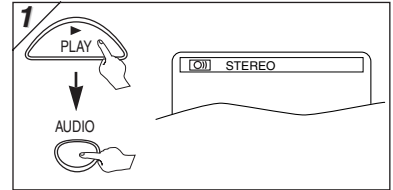

Each time you hit [AUDIO], sound mode changes as example below.

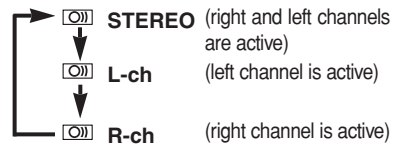

Virtual Surround



You can enjoy stereophonic virtual world on your existing 2 channel stereo system.

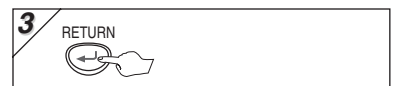
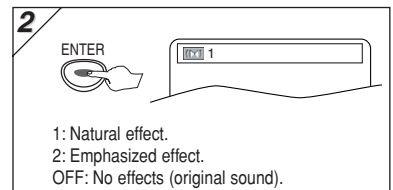
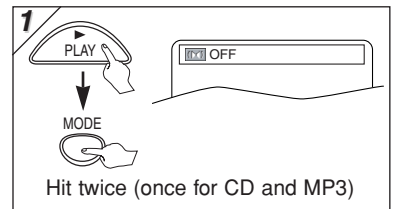

Hint

For CD playback only

- Virtual Surround will not be effective if the sound mode is set to something other than STEREO. Refer to "Stereo Sound Mode".

DVD Setup

QUICK SETUP Menu

You can select the "PLAYER MENU", "TV ASPECT" or "DOLBY DIGITAL" from the "QUICK SETUP" menu quickly.

1 →
 <SETUP MENU>
 Confirm that "QUICK" is selected.

2
 Select the desired item.

• Refer to the sections "PLAYER MENU", "TV ASPECT" or "DOLBY DIGITAL" on page 14 or 15.

CUSTOM Menu

You can change the settings of the unit.

- **QUICK** on pages 14-16 indicates DVD Setup menus also accessible from the "QUICK SETUP" menu.

1 →
 <SETUP MENU>

2
 Select "CUSTOM".

3 →
 Select the desired item.

↓

LANGUAGE menu (page 14 **A**) **DISPLAY menu** (page 15 **B**) **AUDIO menu** (page 15 **C**) **PARENTAL menu** (page 16 **D**) **OTHERS menu** (page 16 **E**)

A LANGUAGE Setting

Follow steps 1) to 3) in the "CUSTOM Menu" section above.

4 Select the desired item.

"LANGUAGE" menu

5 Select the desired language.

AUDIO *1 *2
 (Default: ORIGINAL)
 Sets the audio language.

SUBTITLE: *1 *2
 (Default: OFF)
 Sets the subtitle language.

DISC MENU: *1
 (Default: ENGLISH)
 Sets the language in DVD menu.

PLAYER MENU: QUICK
 (Default: ENGLISH)
 Sets the language for the On-Screen Display.

6 To exit the menu.

Hint

*1
 • Language options are not available with some discs.
 • If "OTHER" is selected in the "AUDIO, SUBTITLE" or "DISC MENU" screen, press four-digit number to enter the code for the desired language. (Refer to the language code list on page 18.)
 • Only the languages supported by the disc can be selected.

*2
 • Language Setting for Audio and Subtitle are not available with some discs. Then use **[AUDIO]** and **[SUBTITLE]**. Details are on page 13.

B DISPLAY Setting

You can change the display functions. Follow steps 1) to 3) in the "CUSTOM Menu" section on page 14.

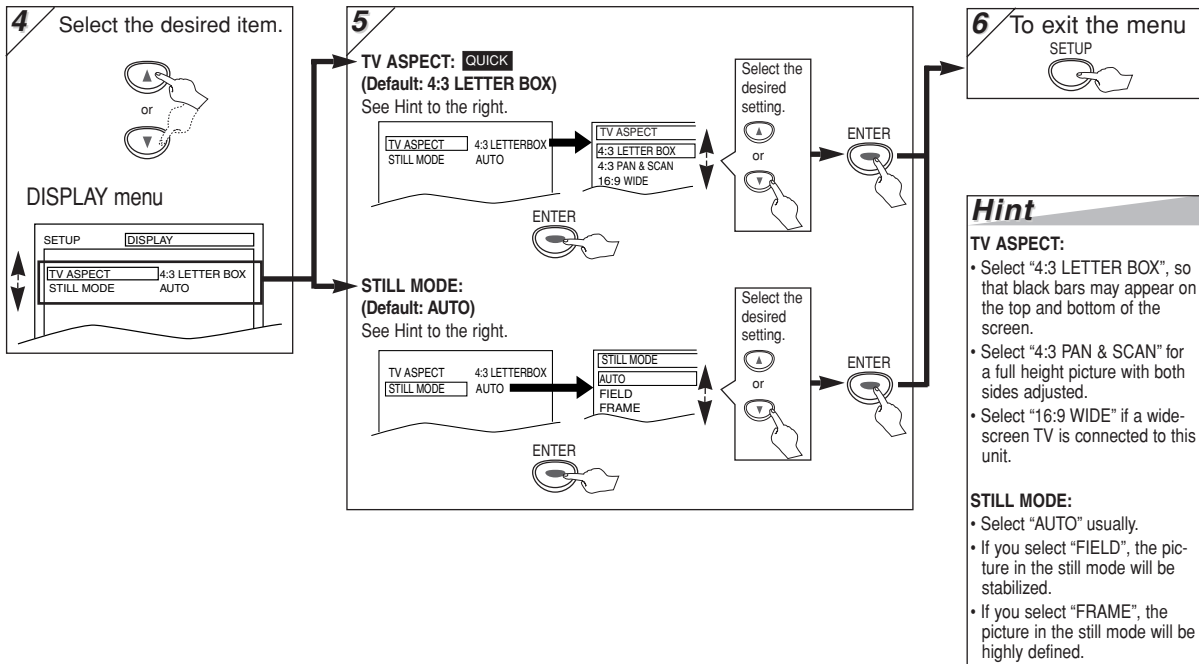

C AUDIO Setting

Choose the appropriate audio settings for your equipments. It only affects during the playback of DVD discs. Follow steps 1) to 3) in the "CUSTOM Menu" section on page 14.

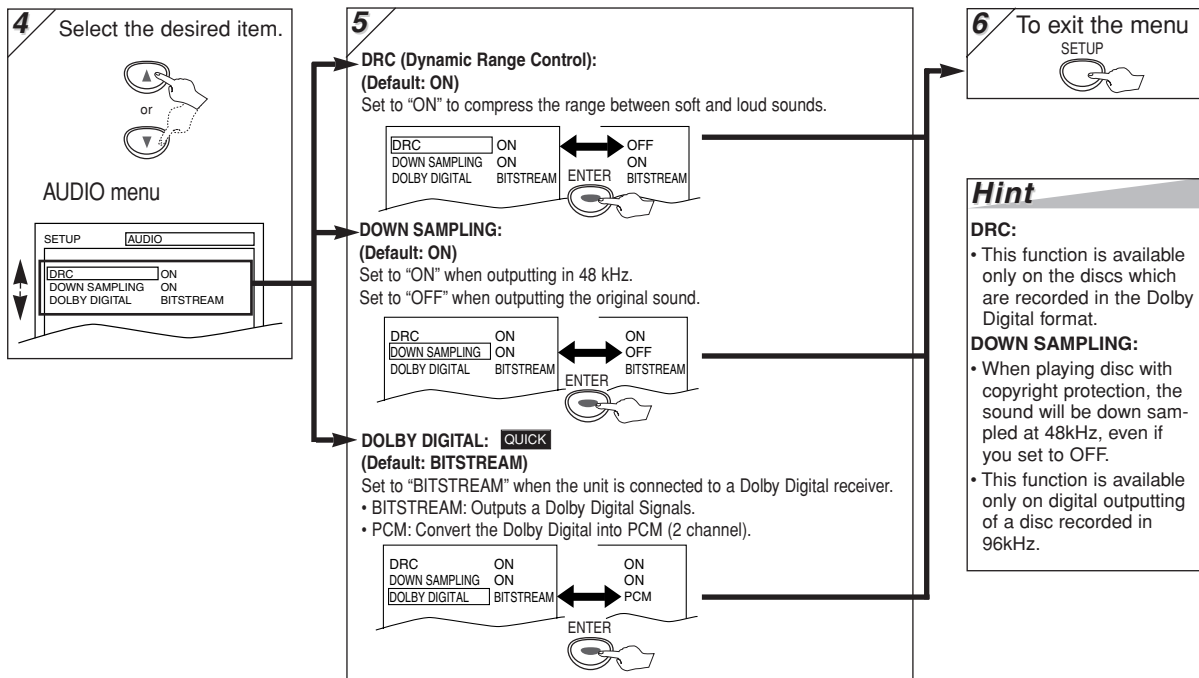

D PARENTAL Setting

Parental Control limits the disc viewing that exceed your settings. (An incorrect password will not play.) This feature prevents your children from viewing inappropriate materials.

Parental Levels

Parental Level allows you to set the rating levels of your DVD discs. Playback will stop if the ratings exceed the levels you set. Follow steps 1) to 3) in the "CUSTOM Menu" section on page 14.

4 Enter your desired four-digit password (except for 4737).

PARENTAL menu

or

If you have set a password already, enter the current four-digit password.

5 Select "PARENTAL LEVEL".

CONTROL LEVELS

- ALL: All parental locks are cancelled.
- Level 8: DVD softwares of any grades (adult/general/children) can be played back.
- Levels 7 to 2: Only DVD softwares intended for general use and children can be played back.
- Level 1: Only DVD softwares intended for children can be played back, with those intended for adult and general use prohibited.

TIPS FOR LEVELS

- 7 [NC-17]: No one under 17 admitted
- 6 [R]: Restricted; under 17 requires accompanying parent or adult guardian
- 4 [PG13]: Unsuitable for children under 13
- 3 [PG]: Parental Guidance suggested
- 1 [G]: General Audience

6 Select the desired level.

7 To exit the menu

Hint

- DVD-Video discs may not respond to the parental lock settings. Make sure this function works with your DVD-Video discs.

To Change the Password for Parental Controls

You can change your password for parental controls. Follow steps 1) to 3) in the "CUSTOM Menu" section on page 14.

4 Enter your desired four-digit password (except for 4737).

PARENTAL menu

5 Select "PASSWORD CHANGE".

6 Enter your new four-digit password (except for 4737).

7 To exit the menu

Hint

- Record the password in case you forget it.
- If you forget the password, hit [4], [7], [3], [7] at step 4), then enter your new password.
- Password will be cleared and parental levels will be set to "ALL".

E OTHERS Setting

You can change the other functions. Follow steps 1) to 3) in the "CUSTOM Menu" section on page 14.

Select the desired item

4

OTHERS menu

5

ANGLE ICON: (Default: ON)
Set to "ON" to show the angle icon when multiple camera angles are available during DVD playback.

AUTO POWER OFF: (Default: ON)
Set to "ON" to turn this unit off automatically after 30 minutes of no use.

6 To exit the menu

Reset to the Default Setting (Except for PARENTAL Setting)

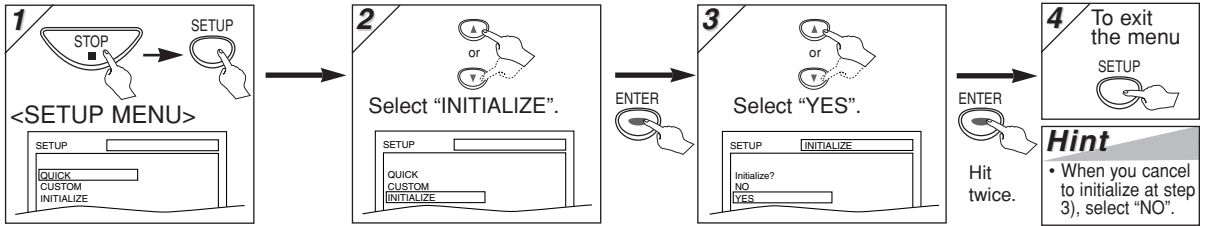

Information

Troubleshooting Guide

If the unit does not perform properly when operated as instructed in this Owner's Manual, check the unit consulting the following checklist.

| Problem | Solution |
|--|--|
| No power | <ul style="list-style-type: none"> -Check if the AC power cord is properly connected. -Unplug the outlet once, and wait for 5-10seconds and then plug it in again |
| No sound or picture | <ul style="list-style-type: none"> -Check if the TV is switched on. -Check the video connection -Check the VIDEO/AUDIO cable connections to the TV (See Connection to a TV) -Set PROGRESSIVE correctly. Turn it on only if your TV has Progressive Scan and you are using the Component Video connections between the unit and the TV. Disable Progressive Scan for all other connections. (See page 6) |
| Distorted picture | <ul style="list-style-type: none"> -Sometimes a small amount of picture distortion may appear. This is not a malfunction. -Connect the unit directly to the TV. |
| Completely distorted picture or black/white picture with DVD | <ul style="list-style-type: none"> -Connect the unit directly to the TV. -Make sure the disc is compatible with the unit. -Check if the INTERLACE/PROGRESSIVE mode is set correctly. See page 6. |
| No sound or distorted sound | <ul style="list-style-type: none"> -Adjust the volume. -Check that the speakers are connected correctly. |
| No audio at digital output | <ul style="list-style-type: none"> -Check the digital connections. -Check if the audio format of the selected audio language matches your receiver capabilities. |
| No DTS audio is output | <ul style="list-style-type: none"> -This unit does not support DTS audio. This is not a malfunction. |
| Picture freezes momentarily during playback | <ul style="list-style-type: none"> -Check the disc for fingerprints/scratches and clean with a soft cloth wiping from center to edge. -Clean the disc |
| Disc can't be played | <ul style="list-style-type: none"> -Clean the disc -Ensure the disc label is facing up. -Check if the disc is defective by trying another disc. -Cancel the parental lock or change the control level. -Insert a correct disc that plays on this unit. -Handle a disc with special care so that it does not have fingerprints, scratches, or dusts on its surface. |
| No return to start-up screen when disc is removed | <ul style="list-style-type: none"> -Reset the unit by switching the unit off, then on again. |
| The unit does not respond to the remote control | <ul style="list-style-type: none"> -Aim the remote control directly at the sensor on the front of the unit. -Reduce the distance to the unit. -Replace the batteries in the remote control. -Re-insert the batteries with their polarities (+/- signs) as indicated. -Tune your radio to an empty AM station so that you hear a lot of noises. Then, turn the volume up. If you hear some signal sound from the radio by pressing buttons on the remote control, the remote control is working. |
| Buttons do not work or the unit stops responding | <ul style="list-style-type: none"> -To completely reset the unit, unplug the AC cord from the AC outlet for 5-10 seconds. |
| The unit does not respond to some operating commands during playback | <ul style="list-style-type: none"> -Operations may not be permitted by the disc. Refer to the instructions of the disc. |
| The unit cannot read CDs/DVDs | <ul style="list-style-type: none"> -Use a commonly available cleaning CD/DVD to clean the lens before sending the unit for repair. |
| Angle does not switch | <ul style="list-style-type: none"> -The angle cannot be switched for DVDs which do not contain multiple angles. In some cases multiple angles are only recorded for specific scenes. |
| Playback does not start when the title is selected | <ul style="list-style-type: none"> -Check the "PARENTAL" setting. |
| The password for rating level has been forgotten | <ul style="list-style-type: none"> -Enter the default password "4737", then your forgotten password will be cleared |
| The PLAY indicator on the front panel flashes | <ul style="list-style-type: none"> -An unacceptable disc is installed. insert a playable disc. |

NOTES:

- Some functions are not available in specific modes, but this is not a malfunction. Read the description in this Owner's Manual for more details on correct operations.
- Playback from a desired track and random playback are not available during program playback.
- Some functions are prohibited on some discs.

Specifications

Output signal format:

NTSC color

Power source:

120 V AC +/- 10%, 60 Hz +/- 0.5%

Power consumption:

10 W (standby: 0.8 W)

Operating temperature:

41°F (5°C) to 104°F (40°C)

Dimensions:

W : 17 3/16" (435 mm)

H : 2" (51 mm)

D : 8 5/16" (211 mm)

Weight :

Approx 2.9 lbs (1.3 kg)

• Designs and specifications are subject to change without notice.

• If there is a discrepancy between languages, the default language will be English.

Language List

| Language | Code | Language | Code | Language | Code | Language | Code |
|-----------------|------|------------------|------|------------------|------|---------------|------|
| Abkhazian | A-B | French [FRE] | 5264 | Macedonian | 5957 | Siswat | 6565 |
| Afar | 4747 | Frisian | 5271 | Malagasy | 5953 | Slovak | 6557 |
| Afrikaans | 4752 | Galician | 5358 | Malay | 5965 | Slovenian | 6558 |
| Albanian | 6563 | Georgian | 5747 | Malayalam | 5958 | Somali | 6561 |
| Amharic | 4759 | German [GER] | 5051 | Maltese | 5966 | Spanish [SPA] | 5165 |
| Arabic | 4764 | Greek [GRE] | 5158 | Maori | 5955 | Sundanese | 6567 |
| Armenian | 5471 | Greenlandic | 5758 | Marathi | 5964 | Swahili | 6569 |
| Assamese | 4765 | Guarani | 5360 | Moldavian | 5961 | Swedish [SWE] | 6568 |
| Aymara | 4771 | Gujarati | 5367 | Mongolian | 5960 | | |
| Azerbaijani | 4772 | Hausa | 5447 | Nauru | 6047 | Tagalog | 6658 |
| Bashkir | 4847 | Hebrew | 5569 | Nepali | 6051 | Tajik | 6653 |
| Basque | 5167 | Hindi | 5455 | Norwegian [NOR] | 6061 | Tamil | 6647 |
| Bengali; Bangla | 4860 | Hungarian [HUN] | 5467 | | | Tatar | 6666 |
| Bhutani | 5072 | | | O-C | | Telugu | 6651 |
| Bihari | 4854 | Icelandic [ICE] | 5565 | Occitan | 6149 | Thai | 6654 |
| Bislama | 4855 | Indonesian | 5560 | Oriya | 6164 | Tibetan | 4861 |
| Breton | 4864 | Interlingua | 5547 | Oromo(Afan) | 6159 | Tigrinya | 6655 |
| Bulgarian | 4853 | Interlingue | 5551 | Panjabi | 6247 | Tonga | 6661 |
| Burmese | 5971 | Inupiak | 5557 | Pashto; Pushto | 6265 | Tsonga | 6665 |
| Byelorussian | 4851 | Irish [IRI] | 5347 | Persian | 5247 | Turkic [TUR] | 6664 |
| | | Italian [ITA] | 5566 | Polish | 6258 | Turkmen | 6657 |
| | | Japanese [JPN] | 5647 | Portuguese [POR] | 6266 | Twi | 6669 |
| | | Javanese | 5669 | Quechua | 6367 | | |
| Cambodian | C-E | Kannada | 5760 | Rhaeto-Romance | 6459 | | |
| Catalan | 4947 | Kashmiri | 5765 | Romanian [RUM] | 6461 | Ukrainian | 6757 |
| Chinese [CHI] | 7254 | Kazakh | 5757 | Russian [RUS] | 6467 | Urdu | 6764 |
| Corsican | 4961 | Kinyarwanda | 6469 | | | Uzbek | 6772 |
| Croatian | 5464 | Kirghiz | 5771 | Samoan | 6559 | Vietnamese | 6855 |
| Czech | 4965 | Kirundi | 6460 | Sangho | 6553 | Volapuk | 6861 |
| Danish [DAN] | 5047 | Korean [KOR] | 5761 | Sanskrit | 6547 | Welsh | 4971 |
| Dutch [DUT] | 6058 | Kurdish | 5767 | Scots Gaelic | 6550 | Wolof | 6961 |
| English [ENG] | 5160 | | | Serbian | 6564 | Xhosa | 7054 |
| Esperanto | 5161 | | | Serbo-Croatian | 6554 | Yiddish | 6555 |
| Estonian | 5166 | Latvian; Lettish | 5868 | Sesotho | 6566 | Yoruba | 7161 |
| | | Lingala | 5860 | Setswana | 6660 | Zulu | 7267 |
| Faroese | F-H | Lithuanian | 5866 | Shona | 6560 | | |
| Fiji | 5256 | | | Sindhi | 6550 | | |
| Finnish [FIN] | 5255 | | | Singhalese | 6555 | | |

If you choose a Language that has a 3 letter language code, the code will be displayed every time you change the Audio or Subtitle language setting on page 13. If you choose any other languages, '---' will be displayed instead. (3 letter language code is written in bracket.)

SYLVANIA LIMITED WARRANTY

FUNAI CORP. will repair this SYLVANIA product, free of charge in the USA in the event of defect in materials or workmanship as follows:

DURATION:

PARTS: FUNAI CORP. will provide parts to replace defective parts without charge for one (1) year from the date of original retail purchase. Certain parts are excluded from this warranty.

LABOR: FUNAI CORP. will provide the labor without charge for a period of ninety (90) days from the date of original retail purchase.

LIMITS AND EXCLUSIONS:

This warranty is extended only to the original retail purchaser. A purchase receipt or other proof of original retail purchase will be required together with the product to obtain service under this warranty.

This warranty shall not be extended to any other person or transferee.

This warranty is void and of no effect if any serial numbers on the product are altered, replaced, defaced, missing or if service was attempted by an unauthorized service center. This SYLVANIA Limited warranty does not apply to any product not purchased and used in the United States.

This product is produced for home use and this warranty only covers failures due to defects in material or workmanship which occurs during normal use. It does not cover damage which occurs in shipment, or failures which are caused by repairs, alterations or product not supplied by FUNAI CORP., or damage which results from accident, misuse, abuse, mishandling, misapplication, alteration, faulty installation, improper maintenance, commercial use such as hotel, rental or office use of this product or damage which results from fire, flood, lightning or other acts of God.

THIS WARRANTY DOES NOT COVER PACKING MATERIALS, ANY ACCESSORIES (EXCEPT REMOTE CONTROL), ANY COSMETIC PARTS, COMPLETE ASSEMBLY PARTS, DEMO OR FLOOR MODELS.

FUNAI CORP. AND ITS REPRESENTATIVES OR AGENTS SHALL IN NO EVENT BE LIABLE FOR ANY GENERAL, INDIRECT OR CONSEQUENTIAL DAMAGES ARISING OUT OF OR OCCASIONED BY THE USE OF OR THE INABILITY TO USE THIS PRODUCT. THIS WARRANTY IS MADE IN LIEU OF ALL OTHER WARRANTIES, EXPRESS OR IMPLIED, AND OF ALL OTHER LIABILITIES ON THE PART OF FUNAI, ALL OTHER WARRANTIES INCLUDING THE WARRANTY OF MERCHANTABILITY, AND FITNESS FOR A PARTICULAR PURPOSE, ARE HEREBY DISCLAIMED BY FUNAI AND ITS REPRESENTATIVES IN THE UNITED STATES. ALL WARRANTY INSPECTIONS AND REPAIRS MUST BE PERFORMED BY A FUNAI AUTHORIZED SERVICE CENTER. THIS WARRANTY IS VALID WHEN THE UNIT IS CARRIED-IN TO FUNAI AUTHORIZED SERVICE FACILITY.

IMPORTANT:

THIS LIMITED WARRANTY GIVES YOU SPECIFIC LEGAL RIGHTS. YOU MAY HAVE OTHER RIGHTS THAT VARY FROM STATE TO STATE. IF, AT ANY TIME DURING THE WARRANTY PERIOD, YOU ARE UNABLE TO OBTAIN SATISFACTION WITH THE REPAIR OF THIS PRODUCT, PLEASE CONTACT FUNAI CORP.

ATTENTION:

FUNAI CORP. RESERVES THE RIGHT TO MODIFY ANY DESIGN OF THIS PRODUCT WITHOUT PRIOR NOTICE.

To locate your nearest SYLVANIA Authorized Service Center or for general service procedure, please call or write to the following:

**FUNAI CORPORATION, INC.
SERVICE CENTER**

19900 Van Ness Avenue, Torrance, CA 90501

Tel : 1-800-968-3429

<http://www.SylvaniaConsumerElectronics.com>

Head Office: 100 North Street, Teterboro, NJ 07608

PLEASE DO NOT SHIP YOUR UNIT TO THE TETERBORO ADDRESS.

1 Conexiones

Si su televisor tiene entradas de AUDIO/VIDEO vea la sección "Connection to a TV" en la página 6 en el Manual de Manejo. En caso contrario, vea la sección "Connecting to RF Modulator" en la página del frente en el Manual de Manejo.

2 Instalación de las pilas en el control remoto



3 Para cambiar el idioma en la pantalla

- Confirme que ha seleccionado "QUICK".
- Confirme que ha seleccionado "PLAYER MENU".
- Seleccione el idioma deseado para las indicaciones en la pantalla.
- Para salir del menú.

4 Reproducción

Antes.

- Encienda el televisor, amplificador y otros equipos conectados a esta unidad. Asegúrese que el televisor y el sintonizador de audio (de venta en los comercios) están en el canal correcto.

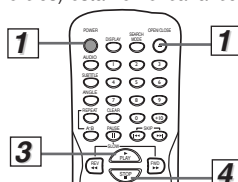

-
- Ponga un disco con la etiqueta hacia arriba.
- Para empezar la reproducción
- Para parar la reproducción

5 Control remoto

| Botón (Orden alfabético) | Disco | | |
|------------------------------|-------|---|--|
| 1 2 3 4 5 6 7 8 9 0 | | • Para seleccionar directamente el capítulo o título. | • Para seleccionar directamente la canción. |
| ▲ ENTER ▼ | | • Para mover el cursor y determinar la posición. | • Para mover el cursor y determinar la posición. |
| A-B | | • Para repetir entre su punto A y B seleccionado. | • Para repetir entre su punto A y B seleccionado.(CD) |
| ANGLE | | • Para seleccionar los ángulos de cámara en un disco. | — |
| AUDIO | | • Para seleccionar idiomas de audio en un disco. | • Para seleccionar ESTÉREO L-ch o R-ch.(CD) |
| CLEAR | | • Para borrar los marcadores. • Para borrar los números mal entrados. • Para borrar el punto para la repetición A-B. | • Para borrar los marcadores.(CD) • Para eliminar el N° de estado en la entrada de programa. • Para borrar los números mal entrados. • Para borrar el punto para la repetición A-B.(CD) |
| DISPLAY | | • Para mostrar el modo de disco actual. | • Para mostrar el modo de disco actual. |
| REV ◀▶ FWD | | • Para buscar en avance/retroceso por un disco. • Para empezar la reproducción en avance lento/retroceso durante el modo de pausa. | • Para buscar en avance/retroceso por un disco. |
| MENU | | • Para llamar el Menú en un disco. | • Para llamar la lista de archivo (MP3) |
| MODE | | • Para activar/desactivar el nivel del negro. • Para activar/desactivar el ambiental virtual. | • Para disponer el orden de reproducción o la reproducción aleatoria. • Para activar/desactivar el ambiental virtual. |
| OPEN/CLOSE ▲ | | • Para abrir o cerrar la bandeja del disco. | • Para abrir o cerrar la bandeja del disco. |
| PAUSE | | • Para hacer una pausa en la reproducción. • Para avanzar la reproducción un cuadro cada vez. | • Para hacer una pausa en la reproducción del disco. |
| ▶▶ PLAY | | • Para empezar la reproducción del disco. | • Para empezar la reproducción del disco. |
| POWER | | • Para encender o apagar la unidad. | • Para encender o apagar la unidad. |
| REPEAT | | • Para reproducir repetidamente un capítulo o título. | • Para reproducir repetidamente una canción o disco.(CD) • Para reproducir repetidamente una canción, grupo o disco (MP3). |
| RETURN ◀▶ | | • Para volver a la operación anterior en el menú. | • Para volver a la operación anterior en el menú. |
| SEARCH MODE | | • Para buscar un capítulo, título o tiempo. • Para colocar o buscar los marcadores. | • Para buscar una canción. • Para buscar el tiempo.(CD) • Para colocar o buscar los marcadores. (CD) |
| SETUP | | • Para llamar el menú de ajustes de DVD. | • Para llamar el menú de ajustes de DVD. |
| SKIP ◀▶▶▶ | | • Para saltar capítulos. | • Para saltar canciones. |
| STOP | | • Para parar la reproducción. | • Para parar la reproducción. |
| SUBTITLE | | • Para seleccionar subtítulos en un disco. | — |
| TOP MENU | | • Para llamar el menú inicial en un disco. | • Para volver al archivo superior de la jerarquía más alta en el programa y en la lista de archivo. (MP3) |
| ZOOM | | • Para ampliar la imagen de video en DVD. | — |

Quick Use Guide

1 Connections

If your TV has AUDIO/VIDEO input jacks, see the section "Connection to a TV" on page 6 of the Owner's Manual. If not, see the section "Connecting to RF Modulator" on the front page of the Owner's Manual.

2 Installing the Batteries for the Remote Control



3 To Change the On-Screen Language

1 Confirm that "QUICK" is selected.

2 Confirm that "PLAYER MENU" is selected.

3 Select the desired language for the On-Screen Display.

4 To exit the menu.

4 Playback

Before:

- Turn on the TV, amplifier and any other equipments which are connected to this unit. Make sure the TV and audio receiver (commercially available) are set to the correct channel.

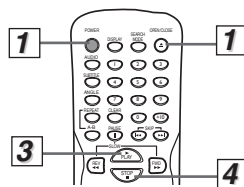

1 POWER → OPEN/CLOSE

2 Insert a disc with label facing up.

3 To start playback

4 To stop playback

5 Remote Control

| Button (Alphabetical order) | Disc | DVD-V | CD MP3 |
|------------------------------|------|--|--|
| 1 2 3 4 5 6 7 8 9 0 | | • To select chapter or title directly. | • To select track directly. |
| ENTER | | • To move the cursor and determine its position. | • To move the cursor and determine its position. |
| A-B | | • To repeat between your chosen point A and B. | • To repeat between your chosen point A and B. (CD) |
| ANGLE | | • To select camera angles on a disc. | — |
| AUDIO | | • To select audio languages on a disc. | • To select STEREO, L-ch or R-ch. (CD) |
| CLEAR | | • To clear the markers. • To clear the numbers entered incorrectly. • To cancel the point for A-B repeat. | • To clear the markers. (CD) • To remove status number in program input. • To clear the numbers entered incorrectly. • To cancel the point for A-B repeat. (CD) |
| DISPLAY | | • To display the current disc mode. | • To display the current disc mode. |
| REV FWD | | • To search forward/backward through a disc. • To begin slow forward /reverse playback during the pause mode. | • To search forward/backward through a disc. |
| MENU | | • To call up the Menu on a disc. | • To call up the file list. (MP3) |
| MODE | | • To set black level on/off. • To set virtual surround on/off. | • To arrange the playing order or play randomly. • To set virtual surround on/off. |
| OPEN/CLOSE | | • To open or close the disc tray. | • To open or close the disc tray. |
| PAUSE | | • To pause disc playback. • To advance playback one frame at a time. | • To pause disc playback. |
| PLAY | | • To begin disc playback. | • To begin disc playback. |
| POWER | | • To turn the unit on or off. | • To turn the unit on or off. |
| REPEAT | | • To play a chapter or title repeatedly. | • To play a track or disc repeatedly. (CD) • To play a track, group or disc repeatedly. (MP3) |
| RETURN | | • To return to the previous operation in menu. | • To return to the previous operation in menu. |
| SEARCH MODE | | • To search chapter, title or time. • To set or search the markers. | • To search track. • To search time. (CD) • To set or search the markers. (CD) |
| SETUP | | • To call up the DVD setup menu. | • To call up the DVD setup menu. |
| SKIP | | • To skip chapters. | • To skip tracks. |
| STOP | | • To stop playback. | • To stop playback. |
| SUBTITLE | | • To select subtitles on a disc. | — |
| TOP MENU | | • To call up the Top Menu on a disc. | • To return to the top file of the highest hierarchy in the program and file list. (MP3) |
| ZOOM | | • To magnify part of a picture. (x2/x4) | — |